

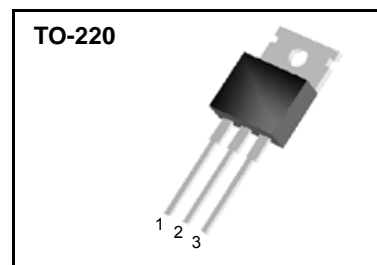
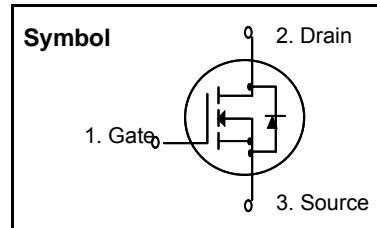
## N-Channel MOSFET

### Features

- Low  $R_{DS(on)}$  ( $0.015\Omega$ ) @  $V_{GS}=10V$
- Low Gate Charge (Typical 65nC)
- Low  $C_{rss}$  (Typical 150pF)
- Improved  $dv/dt$  Capability
- 100% Avalanche Tested
- Maximum Junction Temperature Range ( $175^{\circ}C$ )

### General Description

This Power MOSFET is produced using Wisdom's advanced planar stripe, DMOS technology. This latest technology has been especially designed to minimize on-state resistance, have a low gate charge with superior switching performance, and rugged avalanche characteristics. This Power MOSFET is well suited for synchronous DC-DC Converters and Power Management in portable and battery operated products.



### Absolute Maximum Ratings

Symbol	Parameter	Value	Units
$V_{DSS}$	Drain to Source Voltage	60	V
$I_D$	Continuous Drain Current(@ $T_C = 25^{\circ}C$ )	70	A
	Continuous Drain Current(@ $T_C = 100^{\circ}C$ )	51	A
$I_{DM}$	Drain Current Pulsed (Note 1)	280	A
$V_{GS}$	Gate to Source Voltage	$\pm 25$	V
$E_{AS}$	Single Pulsed Avalanche Energy (Note 2)	800	mJ
$dv/dt$	Peak Diode Recovery $dv/dt$ (Note 3)	7.0	V/ns
$P_D$	Total Power Dissipation(@ $T_C = 25^{\circ}C$ )	158	W
	Derating Factor above $25^{\circ}C$	1.05	W/ $^{\circ}C$
$T_{STG}, T_J$	Operating Junction Temperature & Storage Temperature	- 55 ~ 175	$^{\circ}C$
$T_L$	Maximum Lead Temperature for soldering purpose, 1/8 from Case for 5 seconds.	300	$^{\circ}C$

### Thermal Characteristics

Symbol	Parameter	Value			Units
		Min.	Typ.	Max.	
$R_{\theta JC}$	Thermal Resistance, Junction-to-Case	-	-	0.95	$^{\circ}C/W$
$R_{\theta CS}$	Thermal Resistance, Case to Sink	-	0.5	-	$^{\circ}C/W$
$R_{\theta JA}$	Thermal Resistance, Junction-to-Ambient	-	-	62.5	$^{\circ}C/W$

# SFP70N06

## Electrical Characteristics (T<sub>C</sub> = 25 °C unless otherwise noted)

Symbol	Parameter	Test Conditions	Min	Typ	Max	Units
<b>Off Characteristics</b>						
BV <sub>DSS</sub>	Drain-Source Breakdown Voltage	V <sub>GS</sub> = 0V, I <sub>D</sub> = 250uA	60	-	-	V
$\frac{\Delta BV_{DSS}}{\Delta T_J}$	Breakdown Voltage Temperature coefficient	I <sub>D</sub> = 250uA, referenced to 25 °C	-	0.06	-	V/°C
I <sub>DSS</sub>	Zero Gate Voltage Drain Current	V <sub>DS</sub> = 60V, V <sub>GS</sub> = 0V	-	-	1	uA
		V <sub>DS</sub> = 48V, T <sub>C</sub> = 150 °C	-	-	10	uA
I <sub>GSS</sub>	Gate-Source Leakage, Forward	V <sub>GS</sub> = 25V, V <sub>DS</sub> = 0V	-	-	100	nA
	Gate-Source Leakage, Reverse	V <sub>GS</sub> = -25V, V <sub>DS</sub> = 0V	-	-	-100	nA
<b>On Characteristics</b>						
V <sub>GS(th)</sub>	Gate Threshold Voltage	V <sub>DS</sub> = V <sub>GS</sub> , I <sub>D</sub> = 250uA	2.0	-	4.0	V
R <sub>DS(ON)</sub>	Static Drain-Source On-state Resistance	V <sub>GS</sub> = 10 V, I <sub>D</sub> = 35A	-	0.013	0.015	Ω
<b>Dynamic Characteristics</b>						
C <sub>iss</sub>	Input Capacitance	V <sub>GS</sub> = 0 V, V <sub>DS</sub> = 25V, f = 1MHz	-	2200	2900	pF
C <sub>oss</sub>	Output Capacitance		-	650	850	
C <sub>rss</sub>	Reverse Transfer Capacitance		-	150	195	
<b>Dynamic Characteristics</b>						
t <sub>d(on)</sub>	Turn-on Delay Time	V <sub>DD</sub> = 30V, I <sub>D</sub> = 35A, R <sub>G</sub> = 50Ω * see fig. 13. (Note 4, 5)	-	30	70	ns
t <sub>r</sub>	Rise Time		-	60	130	
t <sub>d(off)</sub>	Turn-off Delay Time		-	125	260	
t <sub>f</sub>	Fall Time		-	95	200	
Q <sub>g</sub>	Total Gate Charge	V <sub>DS</sub> = 48V, V <sub>GS</sub> = 10V, I <sub>D</sub> = 70A * see fig. 12. (Note 4, 5)	-	65	85	nC
Q <sub>gs</sub>	Gate-Source Charge		-	17	-	
Q <sub>gd</sub>	Gate-Drain Charge(Miller Charge)		-	23	-	

## Source-Drain Diode Ratings and Characteristics

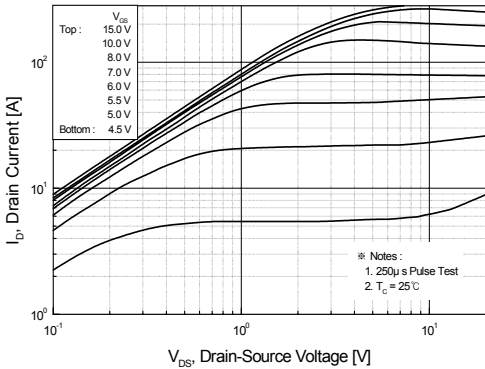
Symbol	Parameter	Test Conditions	Min.	Typ.	Max.	Unit.
I <sub>S</sub>	Continuous Source Current	Integral Reverse p-n Junction Diode in the MOSFET	-	-	70	A
I <sub>SM</sub>	Pulsed Source Current		-	-	280	
V <sub>SD</sub>	Diode Forward Voltage	I <sub>S</sub> = 70A, V <sub>GS</sub> = 0V	-	-	1.5	V
t <sub>rr</sub>	Reverse Recovery Time	I <sub>S</sub> = 70A, V <sub>GS</sub> = 0V, di <sub>F</sub> /dt = 100A/us	-	62	-	ns
Q <sub>rr</sub>	Reverse Recovery Charge		-	110	-	nC

### \* NOTES

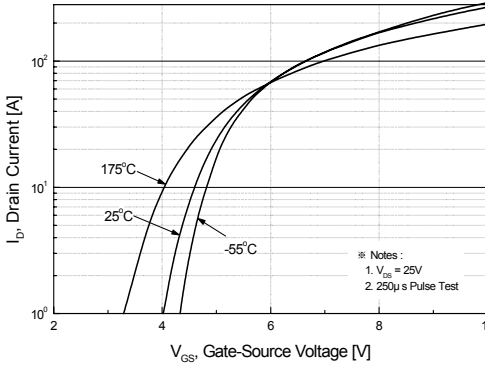
1. Repeativity rating : pulse width limited by junction temperature
2. L = 250 uH, I<sub>AS</sub> = 70A, V<sub>DD</sub> = 25V, R<sub>G</sub> = 0Ω, Starting T<sub>J</sub> = 25°C
3. I<sub>SD</sub> ≤ 70A, di/dt ≤ 300A/us, V<sub>DD</sub> ≤ BV<sub>DSS</sub>, Starting T<sub>J</sub> = 25°C
4. Pulse Test : Pulse Width ≤ 300us, Duty Cycle ≤ 2%
5. Essentially independent of operating temperature.

# SFP70N06

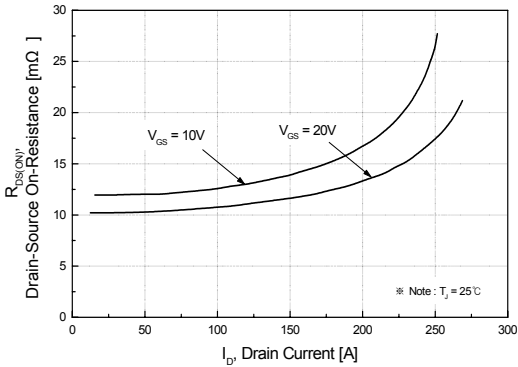
**Fig 1. On-State Characteristics**



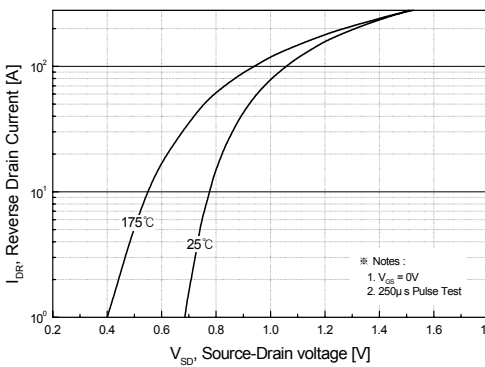
**Fig 2. Transfer Characteristics**



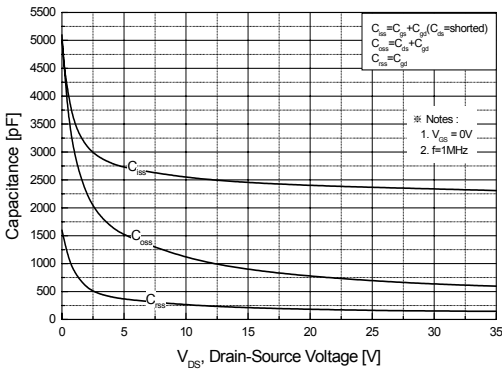
**Fig 3. On Resistance Variation vs. Drain Current and Gate Voltage**



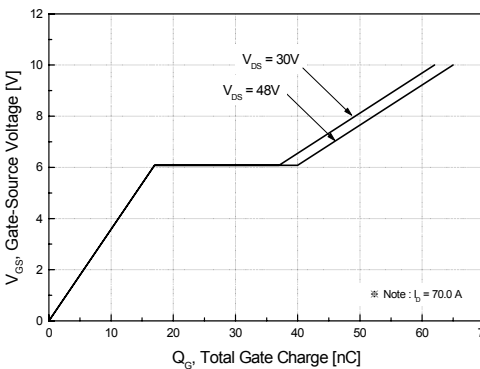
**Fig 4. On State Current vs. Allowable Case Temperature**



**Fig 5. Capacitance Characteristics**

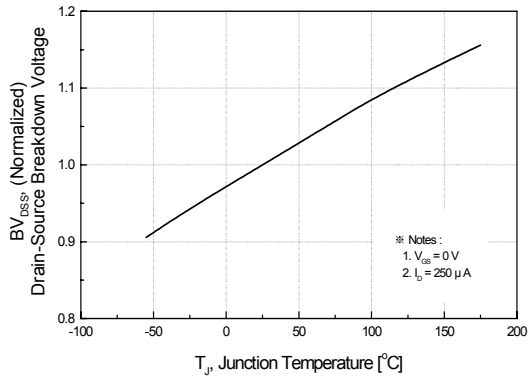


**Fig 6. Gate Charge Characteristics**

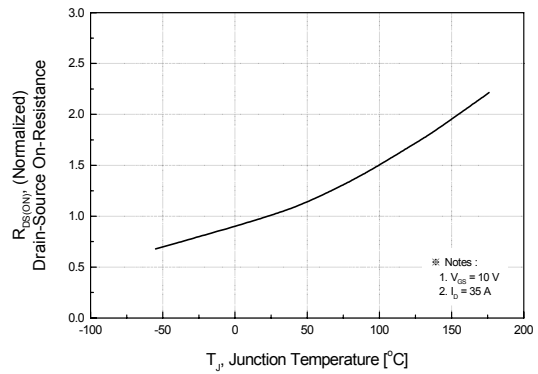


# SFP70N06

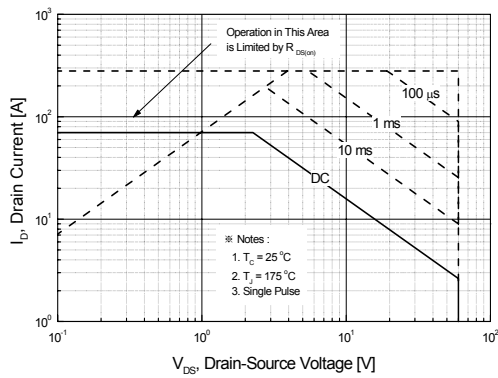
**Fig 7. Breakdown Voltage Variation vs. Junction Temperature**



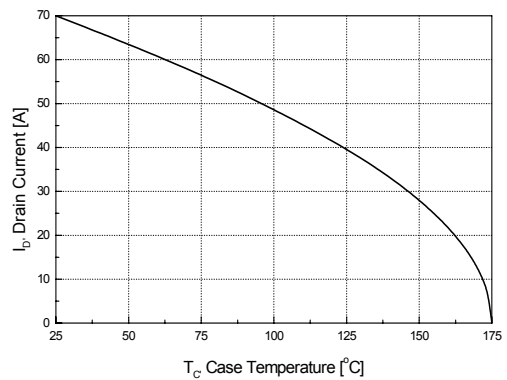
**Fig 8. On-Resistance Variation vs. Junction Temperature**



**Fig 9. Maximum Safe Operating Area**



**Fig 10. Maximum Drain Current vs. Case Temperature**



**Fig 11. Transient Thermal Response Curve**

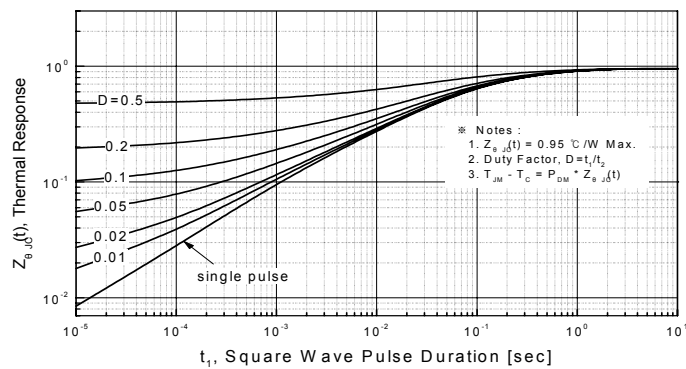


Fig. 12. Gate Charge Test Circuit & Waveforms

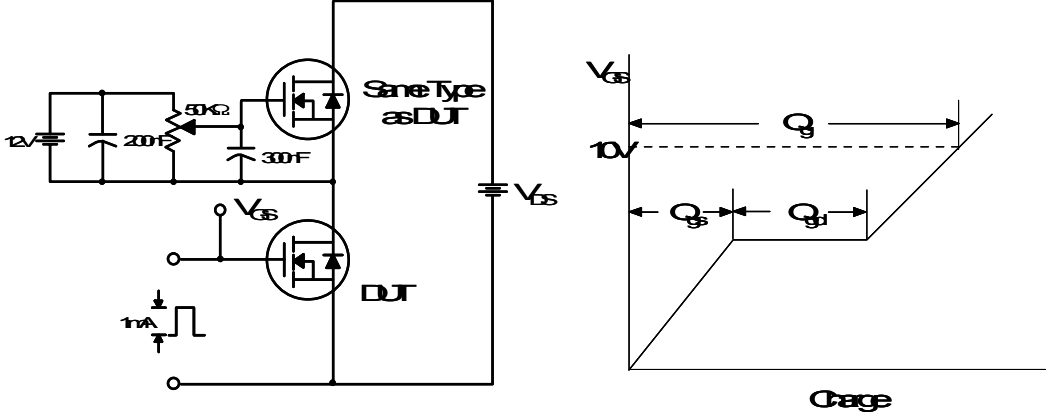


Fig 13. Switching Time Test Circuit & Waveforms

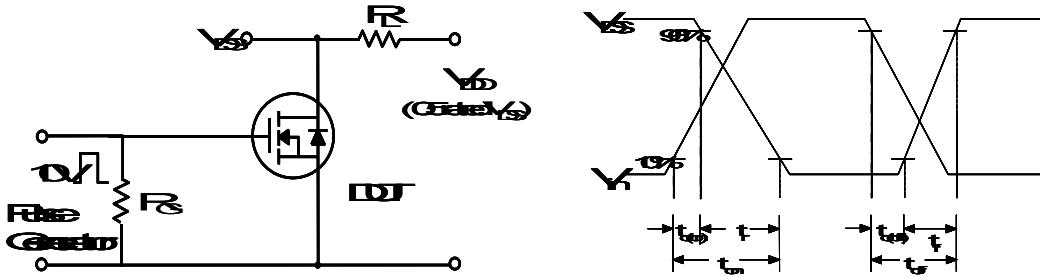
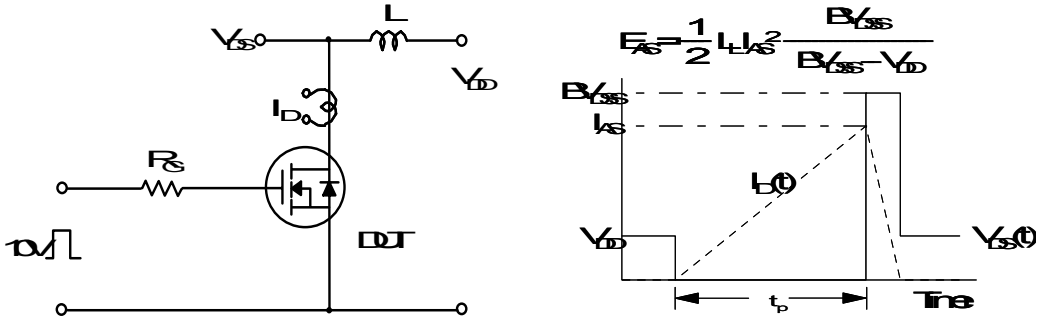
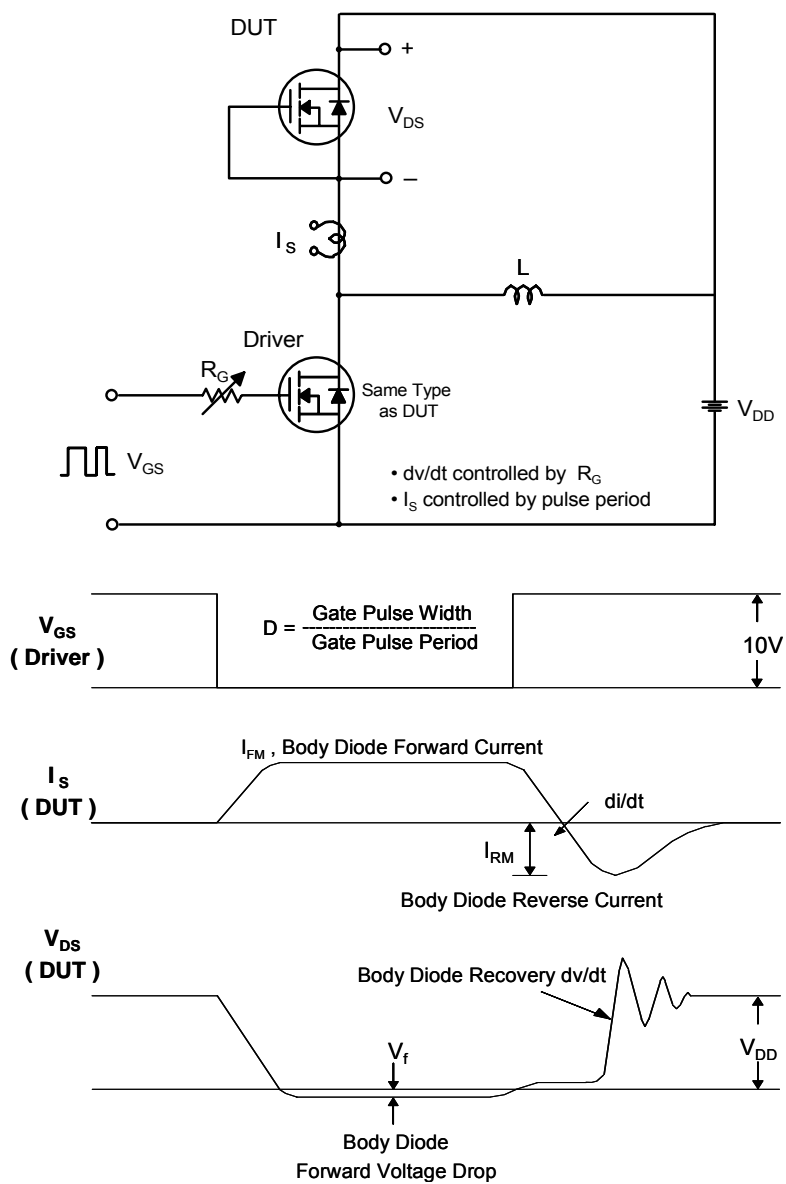


Fig 14. Unclamped Inductive Switching Test Circuit & Waveforms



# SFP70N06

Fig. 15. Peak Diode Recovery dv/dt Test Circuit & Waveforms



# SFP70N06

## TO-220 Package Dimension

Dim.	mm			Inch		
	Min.	Typ.	Max.	Min.	Typ.	Max.
A	9.7		10.1	0.382		0.398
B	6.3		6.7	0.248		0.264
C	9.0		9.47	0.354		0.373
D	12.8		13.3	0.504		0.524
E	1.2		1.4	0.047		0.055
F		1.7			0.067	
G		2.5			0.098	
H	3.0		3.4	0.118		0.134
I	1.25		1.4	0.049		0.055
J	2.4		2.7	0.094		0.106
K	5.0		5.15	0.197		0.203
L	2.2		2.6	0.087		0.102
M	1.25		1.55	0.049		0.061
N	0.45		0.6	0.018		0.024
O	0.6		1.0	0.024		0.039
$\emptyset$		3.6			0.142	

